

LP3984 Micropower 150 mA Ultra Low-Dropout CMOS Voltage Regulator in Subminiature 4-I/O DSBGA Package

Check for Samples: [LP3984](#)

FEATURES

- Miniature 4-I/O DSBGA or SOT-23-5 Package
- Logic controlled enable
- Stable with Tantalum Capacitors
- 1 μF Tantalum Output Capacitor
- Fast Turn-On
- Thermal Shutdown and Short-Circuit Current Limit

KEY SPECIFICATIONS

- 2.5 to 6.0V Input Range
- 150 mA Output
- 60 dB PSRR at 1 kHz, 40 dB at 10 kHz @ 3.1V_{IN}
- $\leq 1.2 \mu\text{A}$ Quiescent Current when Shut Down
- Fast Turn-On Time: 20 μs (typ.)
- 75 mV typ Dropout with 150 mA Load
- -40 to $+125^\circ\text{C}$ Junction Temperature Range for Operation
- 1.5V, 1.8V, 2.9V and 3.1V

APPLICATIONS

- CDMA Cellular Handsets
- Wideband CDMA Cellular Handsets
- GSM Cellular Handsets
- Portable Information Appliances

Typical Application Circuit

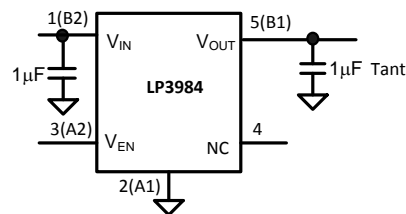

Note: Pin Numbers in parenthesis indicate DSBGA package.

DESCRIPTION

The LP3984 is designed for portable and wireless applications with demanding performance and space requirements.

The LP3984's performance is optimized for battery powered systems to deliver extremely low dropout voltage and low quiescent current. Regulator ground current increases only slightly in dropout, further prolonging the battery life.

Power supply rejection is better than 60 dB at low frequencies and starts to roll off at 10 kHz. High power supply rejection is maintained down to low input voltage levels common to battery operated circuits.

The device is ideal for mobile phone and similar battery powered wireless applications. It provides up to 150 mA from a 2.5V to 6V input. The LP3984 consumes less than 1.2 μA in disable mode and has fast turn-on time less than 20 μs .

The LP3984 is available in a 4-bump DSBGA and 5-pin SOT-23 packages. Performance is specified for -40°C to $+125^\circ\text{C}$ temperature range and is available in 1.5V, 1.8V, 2.9V and 3.1V output voltages. For other output voltage options from 1.5V to 3.5V, please contact TI sales office.



Please be aware that an important notice concerning availability, standard warranty, and use in critical applications of Texas Instruments semiconductor products and disclaimers thereto appears at the end of this data sheet.

All trademarks are the property of their respective owners.

Block Diagram

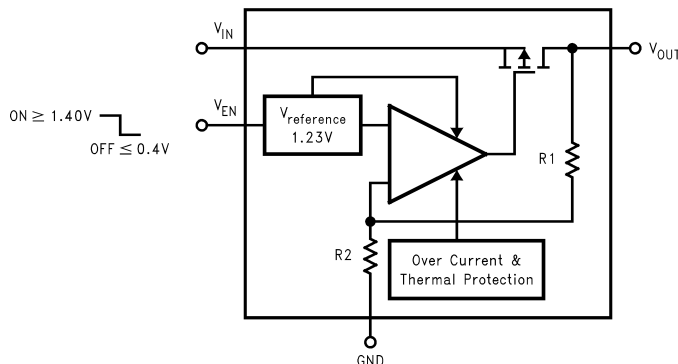

Pin Descriptions

Name	DSBGA (1)	SOT	Function
V _{EN}	A2	3	Enable Input Logic, Enable High
GND	A1	2	Common Ground
V _{OUT}	B1	5	Output Voltage of the LDO
V _{IN}	B2	1	Input Voltage of the LDO
N.C.		4	No Connection

(1) The pin numbering scheme for the DSBGA package was revised in April 2002 to conform to JEDEC standards. Only the pin numbers were revised. No changes to the physical locations of the inputs/outputs were made. For reference purposes, the obsolete numbering scheme had GND as pin 1, V_{OUT} as pin 2, V_{IN} as pin 3 and V_{EN} as pin 4.

Connection Diagram

SOT-23-5 Package

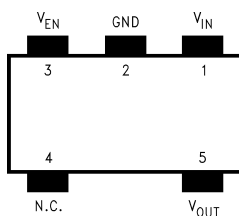

Figure 1. Top View
See Package Number DBV

DSBGA, 4-Bump Package

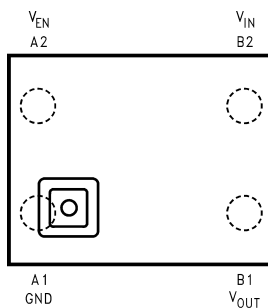

Figure 2. Top View
See Package Number YPB0004



These devices have limited built-in ESD protection. The leads should be shorted together or the device placed in conductive foam during storage or handling to prevent electrostatic damage to the MOS gates.

ABSOLUTE MAXIMUM RATINGS⁽¹⁾⁽²⁾⁽³⁾

V_{IN}, V_{EN}		-0.3 to 6.5V
V_{OUT}		-0.3 to $(V_{IN}+0.3) \leq 6.5V$
Junction Temperature		150°C
Storage Temperature		-65°C to +150°C
Lead Temp.		235°C
Pad Temp. ⁽⁴⁾		235°C
Maximum Power Dissipation ⁽⁵⁾	SOT-23-5	364 mW
	DSBGA	235 mW
ESD Rating ⁽⁶⁾	Human Body Model	2kV
	Machine Model	200V

- (1) Stresses beyond those listed under absolute maximum ratings may cause permanent damage to the device. These are stress ratings only, and functional operation of the device at these or any other conditions beyond those indicated under recommended operating conditions is not implied. Exposure to absolute-maximum-rated conditions for extended periods may affect device reliability.
- (2) All voltages are with respect to the potential at the GND pin.
- (3) If Military/Aerospace specified devices are required, please contact the Texas Instruments Sales Office/ Distributors for availability and specifications.
- (4) Additional information on pad temperature can be found in the TI AN-1112 Application Report ().
- (5) The Absolute Maximum power dissipation depends on the ambient temperature and can be calculated using the formula: $P_D = (T_J - T_A)/\theta_{JA}$, where T_J is the junction temperature, T_A is the ambient temperature, and θ_{JA} is the junction-to-ambient thermal resistance. The 364 mW rating for SOT23-5 appearing under Absolute Maximum Ratings results from substituting the Absolute Maximum junction temperature, 150°C, for T_J , 70°C for T_A , and 220°C/W for θ_{JA} . More power can be dissipated safely at ambient temperatures below 70°C. Less power can be dissipated safely at ambient temperatures above 70°C. The Absolute Maximum power dissipation for SOT23-5 can be increased by 4.5 mW for each degree below 70°C, and it must be derated by 4.5mW for each degree above 70°C.
- (6) The human body model is 100pF discharged through 1.5kΩ resistor into each pin. The machine model is a 200 pF capacitor discharged directly into each pin.

OPERATING RATINGS⁽¹⁾⁽²⁾

V_{IN}		2.5 to 6V
V_{EN}		0 to $(V_{IN}+0.3V) \leq 6V$
Junction Temperature		-40°C to +125°C
Thermal Resistance	θ_{JA} (SOT23-5)	220°C/W
	θ_{JA} (DSBGA)	340°C/W
Maximum Power Dissipation ⁽³⁾	SOT-23-5	250mW
	DSBGA	160mW

- (1) Stresses beyond those listed under absolute maximum ratings may cause permanent damage to the device. These are stress ratings only, and functional operation of the device at these or any other conditions beyond those indicated under recommended operating conditions is not implied. Exposure to absolute-maximum-rated conditions for extended periods may affect device reliability.
- (2) All voltages are with respect to the potential at the GND pin.
- (3) Like the Absolute Maximum power dissipation, the maximum power dissipation for operation depends on the ambient temperature. The 250mW rating for SOT23-5 appearing under Operating Ratings results from substituting the maximum junction temperature for operation, 125°C, for T_J , 70°C for T_A , and 220°C/W for θ_{JA} using the formula: $P_D = (T_J - T_A)/\theta_{JA}$. More power can be dissipated at ambient temperatures below 70°C. Less power can be dissipated at ambient temperatures above 70°C. The maximum power dissipation for operation can be increased by 4.5 mW for each degree below 70°C, and it must be derated by 4.5mW for each degree above 70°C.

ELECTRICAL CHARACTERISTICS

Unless otherwise specified: $V_{IN} = 2.5V$ for 1.5V and 1.8V options, $V_{IN} = V_{OUT} + 0.5$ for output options higher than 2.5V, $C_{IN} = 1 \mu F$, $I_{OUT} = 1mA$, $C_{OUT} = 1 \mu F$, tantalum. Typical values and limits appearing in standard typeface are for $T_J = 25^\circ C$. Limits appearing in **boldface type** apply over the entire junction temperature range for operation, $-40^\circ C$ to $+125^\circ C$. ⁽¹⁾ ⁽²⁾

Symbol	Parameter	Conditions	Typ	Limit		Units
				Min	Max	
ΔV_{OUT}	Output Voltage Tolerance			-1.2 -2.0	1.2 2.0	% of $V_{OUT(nom)}$
	Line Regulation Error	$V_{IN} = 2.5V$ to $4.5V$ for 1.5V and 1.8V options $V_{IN} = (V_{OUT} + 0.5V)$ to $4.5V$ for Voltage options higher than 2.5V	0.05	-0.15	0.15	%/V
	Load Regulation Error ⁽³⁾	$I_{OUT} = 1 mA$ to $150 mA$ LP3984IM5 (SOT-23-5) LP3984IBP (DSBGA)	0.002 0.0009		0.005 0.002	%/mA
PSRR	Power Supply Rejection Ratio	$V_{IN} = V_{OUT(nom)} + 0.2V$, $f = 1 kHz$, $I_{OUT} = 50 mA$, Figure 4	60			dB
		$V_{IN} = V_{OUT(nom)} + 0.2V$, $f = 10 kHz$, $I_{OUT} = 50 mA$, Figure 4	40			
I_Q	Quiescent Current	$V_{EN} = 1.4V$, $I_{OUT} = 0 mA$	80		125	μA
		$V_{EN} = 1.4V$, $I_{OUT} = 0$ to $150 mA$	110		150	
		$V_{EN} = 0.4V$	0.005		1.2	
	Dropout Voltage ⁽⁴⁾	$I_{OUT} = 1 mA$	0.6		2.5	mV
		$I_{OUT} = 50 mA$	25		40	
		$I_{OUT} = 100 mA$	50		80	
		$I_{OUT} = 150 mA$	75		120	
I_{SC}	Short Circuit Current Limit	Output Grounded (Steady State)	600			mA
$I_{OUT(PK)}$	Peak Output Current	$V_{OUT} \geq V_{OUT(nom)} - 5\%$	600	300		mA
T_{ON}	Turn-On Time ⁽⁵⁾		20			μs
e_n	Output Noise Voltage	BW = 10 Hz to 100 kHz, $C_{OUT} = 1\mu F$ tant.	90			μV_{rms}
I_{EN}	Maximum Input Current at EN	$V_{EN} = 0.4$ and $V_{IN} = 6.0$	± 1			nA
V_{IL}	Maximum Low Level Input Voltage at EN	$V_{IN} = 2.5$ to $6.0V$			0.4	V
V_{IH}	Minimum High Level Input Voltage at EN	$V_{IN} = 2.5$ to $6.0V$		1.4		V
C_{OUT}	Output Capacitor	Capacitance		1	22	μF
		ESR		2	10	Ω
TSD	Thermal Shutdown Temperature		160			$^\circ C$
	Thermal Shutdown Hysteresis		20			$^\circ C$

- (1) Min and Max Limits are verified by design, test, or statistical analysis. Typical (Typ.) numbers are not verified, but do represent the most likely norm.
- (2) The target output voltage, which is labeled $V_{OUT(nom)}$, is the desired voltage option.
- (3) An increase in the load current results in a slight decrease in the output voltage and vice versa.
- (4) Dropout voltage is the input-to-output voltage difference at which the output voltage is 100 mV below its nominal value. This specification does not apply for input voltages below 2.5V.
- (5) Turn-on time is time measured between the enable input just exceeding V_{IH} and the output voltage just reaching 95% of its nominal value.

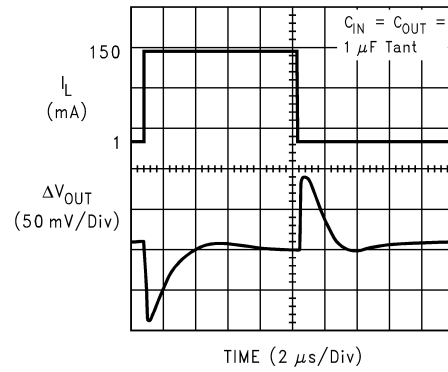

Figure 3. Line Transient Input Test Signal

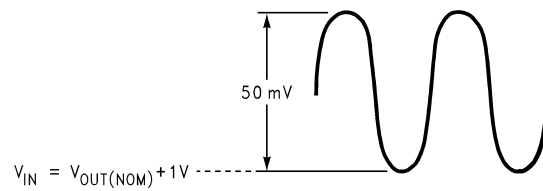

Figure 4. PSRR Input Test Signal

TYPICAL PERFORMANCE CHARACTERISTICS

Unless otherwise specified, $C_{IN} = C_{OUT} = 1 \mu\text{F}$ Tantalum, $V_{IN} = 2.5$ for 1.5V and 1.8V options, $V_{IN} = V_{OUT} + 0.2\text{V}$ for output options higher than 2.5V, $T_A = 25^\circ\text{C}$, Enable pin is tied to V_{IN} .

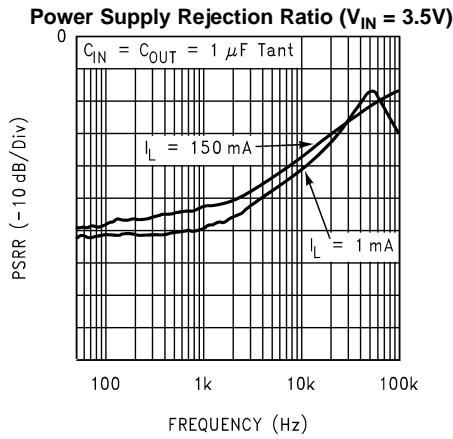

Figure 5.

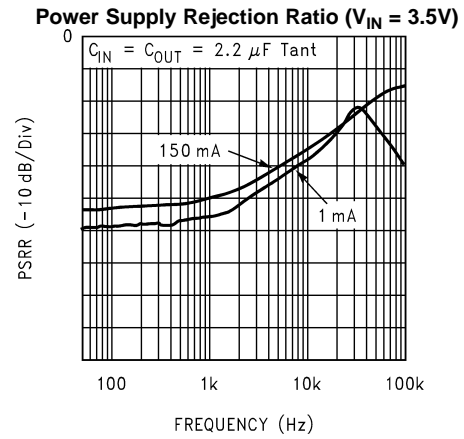

Figure 6.

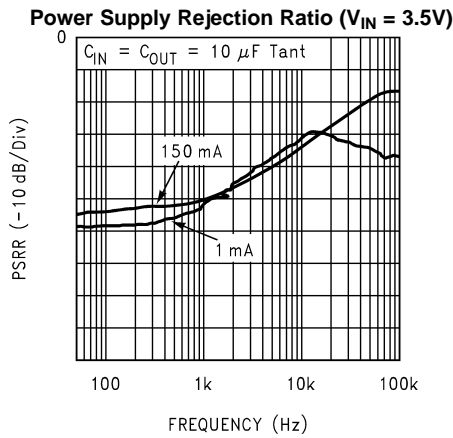

Figure 7.

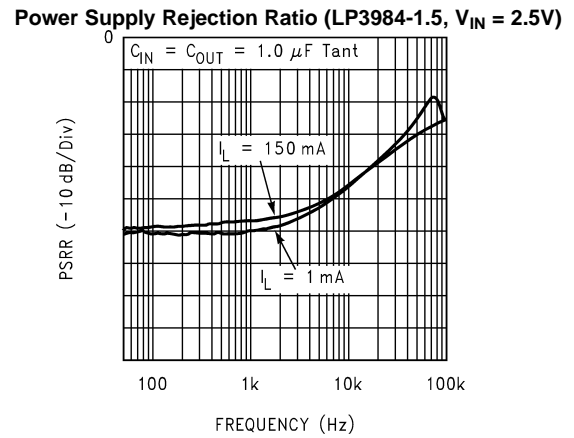

Figure 8.

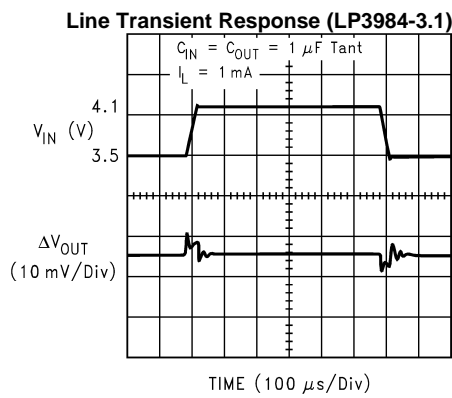

Figure 9.

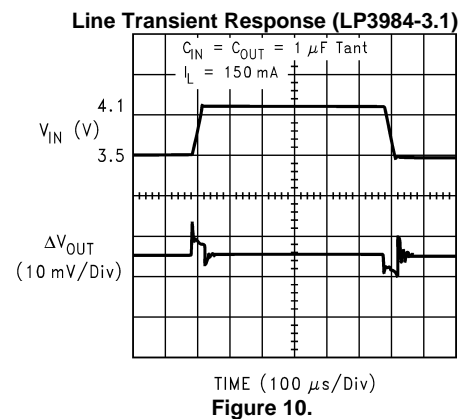

Figure 10.

TYPICAL PERFORMANCE CHARACTERISTICS (continued)

Unless otherwise specified, $C_{IN} = C_{OUT} = 1 \mu\text{F}$ Tantalum, $V_{IN} = 2.5$ for 1.5V and 1.8V options, $V_{IN} = V_{OUT} + 0.2\text{V}$ for output options higher than 2.5V, $T_A = 25^\circ\text{C}$, Enable pin is tied to V_{IN} .

Line Transient Response (LP3984-3.1)

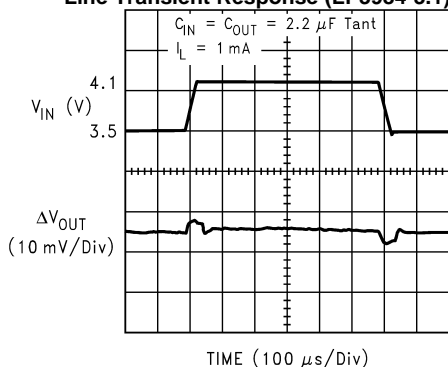

Figure 11.

Line Transient Response (LP3984-3.1)

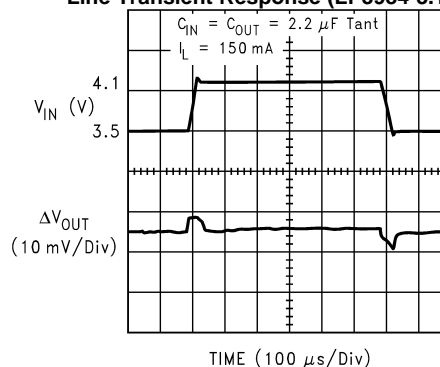

Figure 12.

Line Transient Response (LP3984-3.1)

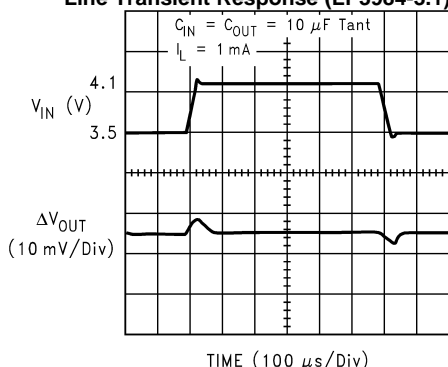

Figure 13.

Line Transient Response (LP3984-3.1)

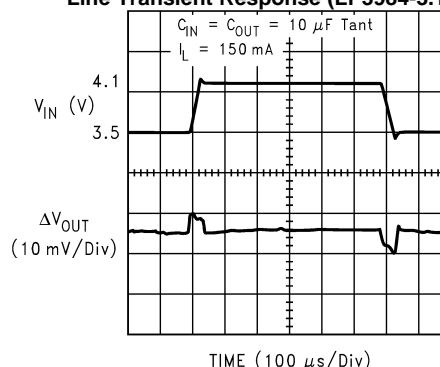

Figure 14.

Start Up Response

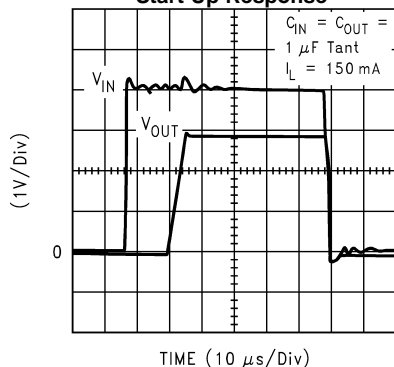

Figure 15.

Start Up Response

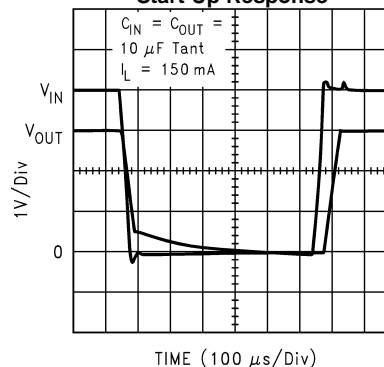

Figure 16.

TYPICAL PERFORMANCE CHARACTERISTICS (continued)

Unless otherwise specified, $C_{IN} = C_{OUT} = 1 \mu\text{F}$ Tantalum, $V_{IN} = 2.5$ for 1.5V and 1.8V options, $V_{IN} = V_{OUT} + 0.2\text{V}$ for output options higher than 2.5V, $T_A = 25^\circ\text{C}$, Enable pin is tied to V_{IN} .

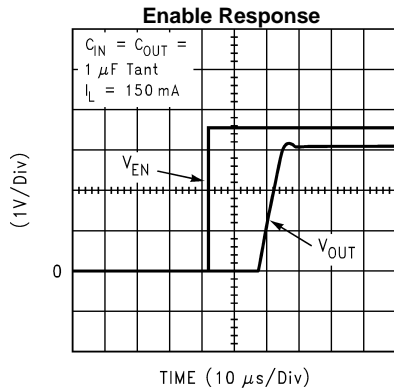

Figure 17.

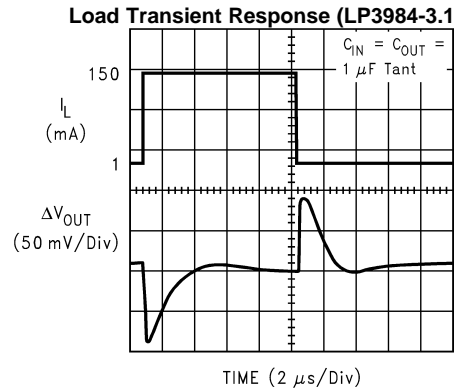

Figure 18.

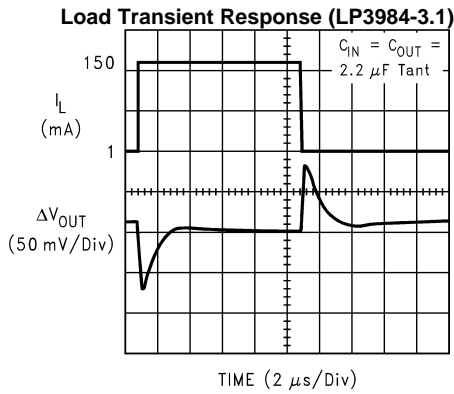

Figure 19.

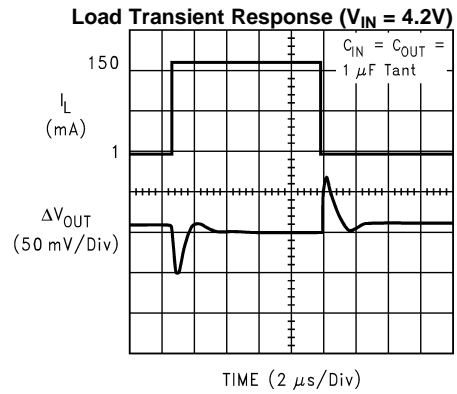

Figure 20.

APPLICATION HINTS

External Capacitors

Like any low-dropout regulator, the LP3984 requires external capacitors for regulator stability. The LP3984 is specifically designed for portable applications requiring minimum board space and smallest components. These capacitors must be correctly selected for good performance.

Input Capacitors

An input capacitance of $\cong 1 \mu\text{F}$ is required between the LP3984 input pin and ground (the amount of the capacitance may be increased without limit).

This capacitor must be located a distance of not more than 1 cm from the input pin and returned to a clean analog ground. Any good quality ceramic, tantalum, or film capacitor may be used at the input.

Important: Tantalum capacitors can suffer catastrophic failures due to surge current when connected to a low-impedance source of power (like a battery or a very large capacitor). If a tantalum capacitor is used at the input, it must be specified by the manufacturer to have a surge current rating sufficient for the application.

There are no requirements for the ESR on the input capacitor, but tolerance and temperature coefficient must be considered when selecting the capacitor to ensure the capacitance will be $\cong 1 \mu\text{F}$ over the entire operating temperature range.

Output Capacitor

The LP3984 is designed specifically to work with tantalum output capacitors. A tantalum capacitor in 1 to 22 μF range with 2 Ω to 10 Ω ESR range is suitable in the LP3984 application circuit.

It may also be possible to use film capacitors at the output, but these are not as attractive for reasons of size and cost.

The output capacitor must meet the requirement for minimum amount of capacitance and also have an ESR (Equivalent Series Resistance) value which is within a stable range (2 Ω to 10 Ω).

No-Load Stability

The LP3984 will remain stable and in regulation with no external load. This is specially important in CMOS RAM keep-alive applications.

On/Off Input Operation

The LP3984 is turned off by pulling the V_{EN} pin low, and turned on by pulling it high. If this feature is not used, the V_{EN} pin should be tied to V_{IN} to keep the regulator output on at all times. To assure proper operation, the signal source used to drive the V_{EN} input must be able to swing above and below the specified turn-on/off voltage thresholds listed in the Electrical Characteristics section under V_{IL} and V_{IH} .

Fast On-Time

The LP3984 output is turned on after V_{ref} voltage reaches its final value (1.23V nominal). To speed up this process, the noise reduction capacitor at the bypass pin is charged with an internal 70 μA current source. The current source is turned off when the bandgap voltage reaches approximately 95% of its final value. The turn-on time is determined by the time constant of the bypass capacitor. The smaller the capacitor value, the shorter the turn-on time, but less noise gets reduced. As a result, turn-on time and noise reduction need to be taken into design consideration when choosing the value of the bypass capacitor.

DSBGA Mounting

The DSBGA package requires specific mounting techniques which are detailed in the AN-1112 Application Report ([SNVA009](#)). Referring to the section *PCB Layout*; note that the pad style which must be used with the 5-pin package is NSMD (non-solder mask defined) type.

For best results during assembly, alignment ordinals on the PC board may be used to facilitate placement of the DSBGA device.

DSBGA Light Sensitivity

Exposing the DSBGA device to direct sunlight will cause mis-operation of the device. Light sources such as halogen lamps can affect electrical performance if brought near to the device.

The wavelengths which have most detrimental effect are reds and infra-reds, which means that the fluorescent lighting used inside most buildings has very little effect on performance. A DSBGA test board was brought to within 1 cm of a fluorescent desk lamp and the effect on the regulated output voltage was negligible, showing a deviation of less than 0.1% from nominal.

REVISION HISTORY

Changes from Revision D (May 2013) to Revision E **Page**

- Changed layout of National Data Sheet to TI format; correct typos [10](#)
-

Changes from Revision E (May 2013) to Revision F **Page**

- Deleted 2.0V option which is obsoleted [1](#)
 - Deleted legacy ordering table [3](#)
-

PACKAGING INFORMATION

Orderable Device	Status (1)	Package Type	Package Drawing	Pins	Package Qty	Eco Plan (2)	Lead/Ball Finish (6)	MSL Peak Temp (3)	Op Temp (°C)	Device Marking (4/5)	Samples
LP3984IMF-1.5	LIFEBUY	SOT-23	DBV	5	1000	TBD	Call TI	Call TI		LEAB	
LP3984IMF-1.5/NOPB	LIFEBUY	SOT-23	DBV	5	1000	Green (RoHS & no Sb/Br)	CU SN	Level-1-260C-UNLIM		LEAB	
LP3984IMF-1.8	LIFEBUY	SOT-23	DBV	5	1000	TBD	Call TI	Call TI		LEBB	
LP3984IMF-1.8/NOPB	LIFEBUY	SOT-23	DBV	5	1000	Green (RoHS & no Sb/Br)	CU SN	Level-1-260C-UNLIM		LEBB	
LP3984IMF-3.1/NOPB	LIFEBUY	SOT-23	DBV	5	1000	Green (RoHS & no Sb/Br)	CU SN	Level-1-260C-UNLIM	-40 to 125	LEDB	
LP3984IMFX-1.8	NRND	SOT-23	DBV	5		TBD	Call TI	Call TI	-40 to 125	LEBB	
LP3984IMFX-1.8/NOPB	LIFEBUY	SOT-23	DBV	5	3000	Green (RoHS & no Sb/Br)	CU SN	Level-1-260C-UNLIM	-40 to 125	LEBB	
LP3984ITP-2.9/NOPB	LIFEBUY	DSBGA	YPB	4	250	Green (RoHS & no Sb/Br)	SNAGCU	Level-1-260C-UNLIM	-40 to 125		
LP3984ITPX-1.8/NOPB	LIFEBUY	DSBGA	YPB	4	3000	Green (RoHS & no Sb/Br)	SNAGCU	Level-1-260C-UNLIM	-40 to 125		

(1) The marketing status values are defined as follows:

ACTIVE: Product device recommended for new designs.

LIFEBUY: TI has announced that the device will be discontinued, and a lifetime-buy period is in effect.

NRND: Not recommended for new designs. Device is in production to support existing customers, but TI does not recommend using this part in a new design.

PREVIEW: Device has been announced but is not in production. Samples may or may not be available.

OBSOLETE: TI has discontinued the production of the device.

(2) Eco Plan - The planned eco-friendly classification: Pb-Free (RoHS), Pb-Free (RoHS Exempt), or Green (RoHS & no Sb/Br) - please check <http://www.ti.com/productcontent> for the latest availability information and additional product content details.

TBD: The Pb-Free/Green conversion plan has not been defined.

Pb-Free (RoHS): TI's terms "Lead-Free" or "Pb-Free" mean semiconductor products that are compatible with the current RoHS requirements for all 6 substances, including the requirement that lead not exceed 0.1% by weight in homogeneous materials. Where designed to be soldered at high temperatures, TI Pb-Free products are suitable for use in specified lead-free processes.

Pb-Free (RoHS Exempt): This component has a RoHS exemption for either 1) lead-based flip-chip solder bumps used between the die and package, or 2) lead-based die adhesive used between the die and leadframe. The component is otherwise considered Pb-Free (RoHS compatible) as defined above.

Green (RoHS & no Sb/Br): TI defines "Green" to mean Pb-Free (RoHS compatible), and free of Bromine (Br) and Antimony (Sb) based flame retardants (Br or Sb do not exceed 0.1% by weight in homogeneous material)

(3) MSL, Peak Temp. - The Moisture Sensitivity Level rating according to the JEDEC industry standard classifications, and peak solder temperature.

(4) There may be additional marking, which relates to the logo, the lot trace code information, or the environmental category on the device.

⁽⁵⁾ Multiple Device Markings will be inside parentheses. Only one Device Marking contained in parentheses and separated by a "~" will appear on a device. If a line is indented then it is a continuation of the previous line and the two combined represent the entire Device Marking for that device.

⁽⁶⁾ Lead/Ball Finish - Orderable Devices may have multiple material finish options. Finish options are separated by a vertical ruled line. Lead/Ball Finish values may wrap to two lines if the finish value exceeds the maximum column width.

Important Information and Disclaimer:The information provided on this page represents TI's knowledge and belief as of the date that it is provided. TI bases its knowledge and belief on information provided by third parties, and makes no representation or warranty as to the accuracy of such information. Efforts are underway to better integrate information from third parties. TI has taken and continues to take reasonable steps to provide representative and accurate information but may not have conducted destructive testing or chemical analysis on incoming materials and chemicals. TI and TI suppliers consider certain information to be proprietary, and thus CAS numbers and other limited information may not be available for release.

In no event shall TI's liability arising out of such information exceed the total purchase price of the TI part(s) at issue in this document sold by TI to Customer on an annual basis.

TAPE AND REEL INFORMATION

QUADRANT ASSIGNMENTS FOR PIN 1 ORIENTATION IN TAPE

*All dimensions are nominal

Device	Package Type	Package Drawing	Pins	SPQ	Reel Diameter (mm)	Reel Width W1 (mm)	A0 (mm)	B0 (mm)	K0 (mm)	P1 (mm)	W (mm)	Pin1 Quadrant
LP3984IMF-1.5	SOT-23	DBV	5	1000	178.0	8.4	3.2	3.2	1.4	4.0	8.0	Q3
LP3984IMF-1.5/NOPB	SOT-23	DBV	5	1000	178.0	8.4	3.2	3.2	1.4	4.0	8.0	Q3
LP3984IMF-1.8	SOT-23	DBV	5	1000	178.0	8.4	3.2	3.2	1.4	4.0	8.0	Q3
LP3984IMF-1.8/NOPB	SOT-23	DBV	5	1000	178.0	8.4	3.2	3.2	1.4	4.0	8.0	Q3
LP3984IMF-3.1/NOPB	SOT-23	DBV	5	1000	178.0	8.4	3.2	3.2	1.4	4.0	8.0	Q3
LP3984IMFX-1.8/NOPB	SOT-23	DBV	5	3000	178.0	8.4	3.2	3.2	1.4	4.0	8.0	Q3
LP3984ITP-2.9/NOPB	DSBGA	YPB	4	250	178.0	8.4	1.02	1.09	0.66	4.0	8.0	Q1
LP3984ITPX-1.8/NOPB	DSBGA	YPB	4	3000	178.0	8.4	1.02	1.09	0.66	4.0	8.0	Q1

TAPE AND REEL BOX DIMENSIONS

*All dimensions are nominal

Device	Package Type	Package Drawing	Pins	SPQ	Length (mm)	Width (mm)	Height (mm)
LP3984IMF-1.5	SOT-23	DBV	5	1000	210.0	185.0	35.0
LP3984IMF-1.5/NOPB	SOT-23	DBV	5	1000	210.0	185.0	35.0
LP3984IMF-1.8	SOT-23	DBV	5	1000	210.0	185.0	35.0
LP3984IMF-1.8/NOPB	SOT-23	DBV	5	1000	210.0	185.0	35.0
LP3984IMF-3.1/NOPB	SOT-23	DBV	5	1000	210.0	185.0	35.0
LP3984IMFX-1.8/NOPB	SOT-23	DBV	5	3000	210.0	185.0	35.0
LP3984ITP-2.9/NOPB	DSBGA	YPB	4	250	210.0	185.0	35.0
LP3984ITPX-1.8/NOPB	DSBGA	YPB	4	3000	210.0	185.0	35.0

DBV (R-PDSO-G5)

PLASTIC SMALL-OUTLINE PACKAGE



- NOTES:
- A. All linear dimensions are in millimeters.
 - B. This drawing is subject to change without notice.
 - C. Body dimensions do not include mold flash or protrusion. Mold flash and protrusion shall not exceed 0.15 per side.
 - D. Falls within JEDEC MO-178 Variation AA.

DBV (R-PDSO-G5)

PLASTIC SMALL OUTLINE



- NOTES:
- A. All linear dimensions are in millimeters.
 - B. This drawing is subject to change without notice.
 - C. Customers should place a note on the circuit board fabrication drawing not to alter the center solder mask defined pad.
 - D. Publication IPC-7351 is recommended for alternate designs.
 - E. Laser cutting apertures with trapezoidal walls and also rounding corners will offer better paste release. Customers should contact their board assembly site for stencil design recommendations. Example stencil design based on a 50% volumetric metal load solder paste. Refer to IPC-7525 for other stencil recommendations.

YPB0004

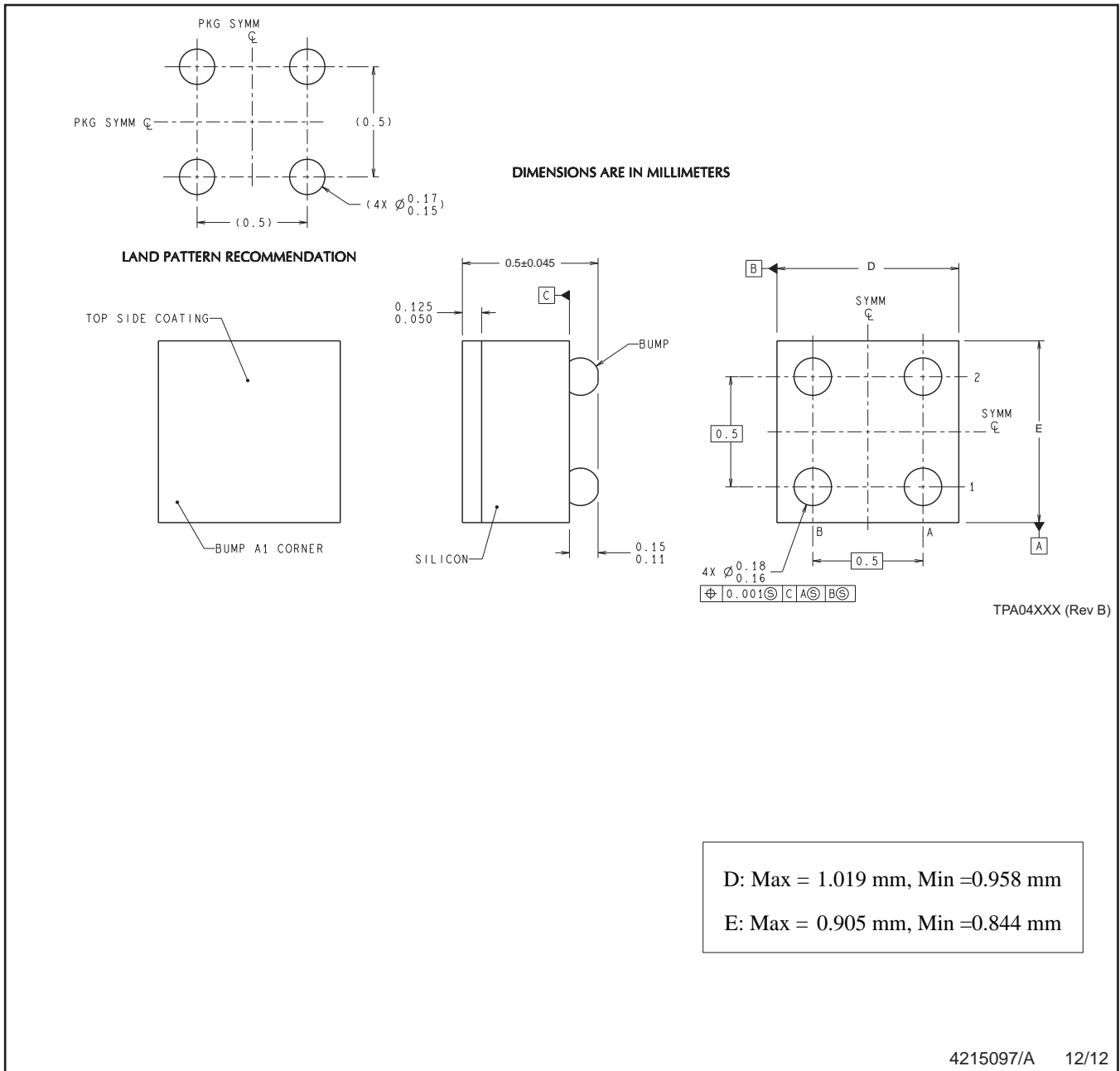

NOTES: A. All linear dimensions are in millimeters. Dimensioning and tolerancing per ASME Y14.5M-1994.
 B. This drawing is subject to change without notice.

IMPORTANT NOTICE

Texas Instruments Incorporated and its subsidiaries (TI) reserve the right to make corrections, enhancements, improvements and other changes to its semiconductor products and services per JESD46, latest issue, and to discontinue any product or service per JESD48, latest issue. Buyers should obtain the latest relevant information before placing orders and should verify that such information is current and complete. All semiconductor products (also referred to herein as "components") are sold subject to TI's terms and conditions of sale supplied at the time of order acknowledgment.

TI warrants performance of its components to the specifications applicable at the time of sale, in accordance with the warranty in TI's terms and conditions of sale of semiconductor products. Testing and other quality control techniques are used to the extent TI deems necessary to support this warranty. Except where mandated by applicable law, testing of all parameters of each component is not necessarily performed.

TI assumes no liability for applications assistance or the design of Buyers' products. Buyers are responsible for their products and applications using TI components. To minimize the risks associated with Buyers' products and applications, Buyers should provide adequate design and operating safeguards.

TI does not warrant or represent that any license, either express or implied, is granted under any patent right, copyright, mask work right, or other intellectual property right relating to any combination, machine, or process in which TI components or services are used. Information published by TI regarding third-party products or services does not constitute a license to use such products or services or a warranty or endorsement thereof. Use of such information may require a license from a third party under the patents or other intellectual property of the third party, or a license from TI under the patents or other intellectual property of TI.

Reproduction of significant portions of TI information in TI data books or data sheets is permissible only if reproduction is without alteration and is accompanied by all associated warranties, conditions, limitations, and notices. TI is not responsible or liable for such altered documentation. Information of third parties may be subject to additional restrictions.

Resale of TI components or services with statements different from or beyond the parameters stated by TI for that component or service voids all express and any implied warranties for the associated TI component or service and is an unfair and deceptive business practice. TI is not responsible or liable for any such statements.

Buyer acknowledges and agrees that it is solely responsible for compliance with all legal, regulatory and safety-related requirements concerning its products, and any use of TI components in its applications, notwithstanding any applications-related information or support that may be provided by TI. Buyer represents and agrees that it has all the necessary expertise to create and implement safeguards which anticipate dangerous consequences of failures, monitor failures and their consequences, lessen the likelihood of failures that might cause harm and take appropriate remedial actions. Buyer will fully indemnify TI and its representatives against any damages arising out of the use of any TI components in safety-critical applications.

In some cases, TI components may be promoted specifically to facilitate safety-related applications. With such components, TI's goal is to help enable customers to design and create their own end-product solutions that meet applicable functional safety standards and requirements. Nonetheless, such components are subject to these terms.

No TI components are authorized for use in FDA Class III (or similar life-critical medical equipment) unless authorized officers of the parties have executed a special agreement specifically governing such use.

Only those TI components which TI has specifically designated as military grade or "enhanced plastic" are designed and intended for use in military/aerospace applications or environments. Buyer acknowledges and agrees that any military or aerospace use of TI components which have **not** been so designated is solely at the Buyer's risk, and that Buyer is solely responsible for compliance with all legal and regulatory requirements in connection with such use.

TI has specifically designated certain components as meeting ISO/TS16949 requirements, mainly for automotive use. In any case of use of non-designated products, TI will not be responsible for any failure to meet ISO/TS16949.

Products

Audio	www.ti.com/audio
Amplifiers	amplifier.ti.com
Data Converters	dataconverter.ti.com
DLP® Products	www.dlp.com
DSP	dsp.ti.com
Clocks and Timers	www.ti.com/clocks
Interface	interface.ti.com
Logic	logic.ti.com
Power Mgmt	power.ti.com
Microcontrollers	microcontroller.ti.com
RFID	www.ti-rfid.com
OMAP Applications Processors	www.ti.com/omap
Wireless Connectivity	www.ti.com/wirelessconnectivity

Applications

Automotive and Transportation	www.ti.com/automotive
Communications and Telecom	www.ti.com/communications
Computers and Peripherals	www.ti.com/computers
Consumer Electronics	www.ti.com/consumer-apps
Energy and Lighting	www.ti.com/energy
Industrial	www.ti.com/industrial
Medical	www.ti.com/medical
Security	www.ti.com/security
Space, Avionics and Defense	www.ti.com/space-avionics-defense
Video and Imaging	www.ti.com/video

TI E2E Community

e2e.ti.com